

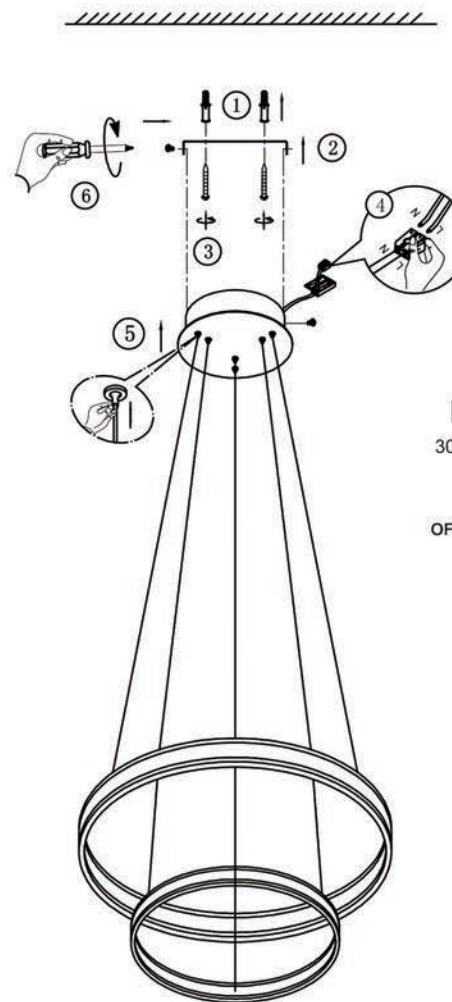

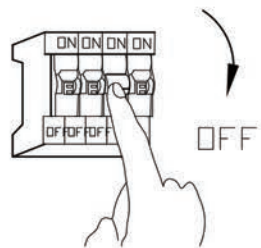

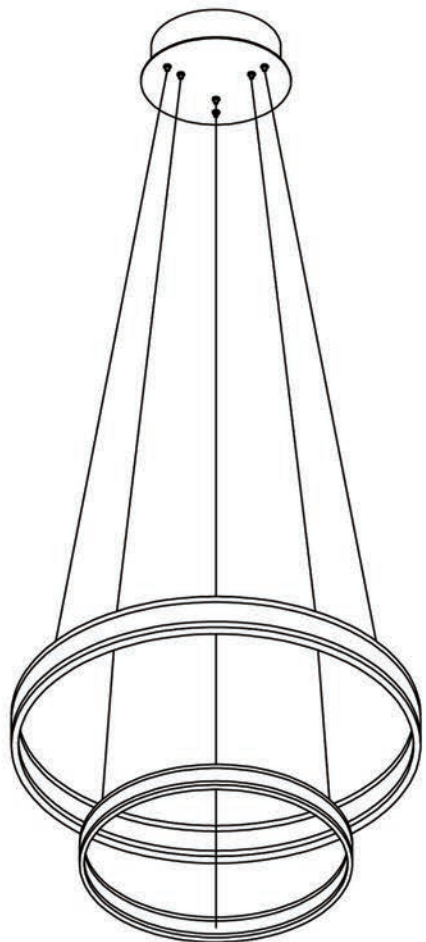

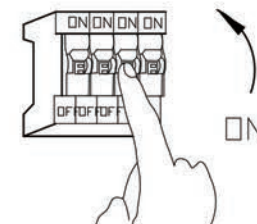







ITEM NO.:BL12503/BL12504



REMARKS: "M1 ,M2"
Hold for 3 seconds to save, then press
the button to change the brightness



2.4G Dimmer Remote Control Instruction

	1		<p>1. Control the main circuit</p> <p>2. Pairing code : Lamp connect electricity with three seconds , hold on the open button 3 times to match the lamp.</p> <p>3. Clearing code : hold on the o button three time continuously, the lights flash twice.</p>
	2		2. Press this button to turn off the lamp
	3		DIM the output power is lightened from 20% to 100%
	4		4. Color temperature up, no cycle function
	5		5. Dim the output power from 100% to 20%
	6		Time set 30 minutes, press this key ,the light will flash once. press any key to turn off the function
	7		7. Night model, output power is lightened 5%. press off button can turn off it .
	8		/
	9		9. Gradual change cool white. 100% warm light, 50% warm light and 50% white light , 100% white light
	10		10. Gradual change cool white Change to warm light ,(warm light), no cycle.
	11		11. Current Brightness, and warm- other -white
	12		/