

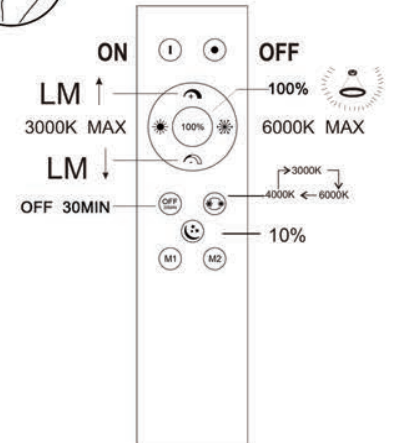

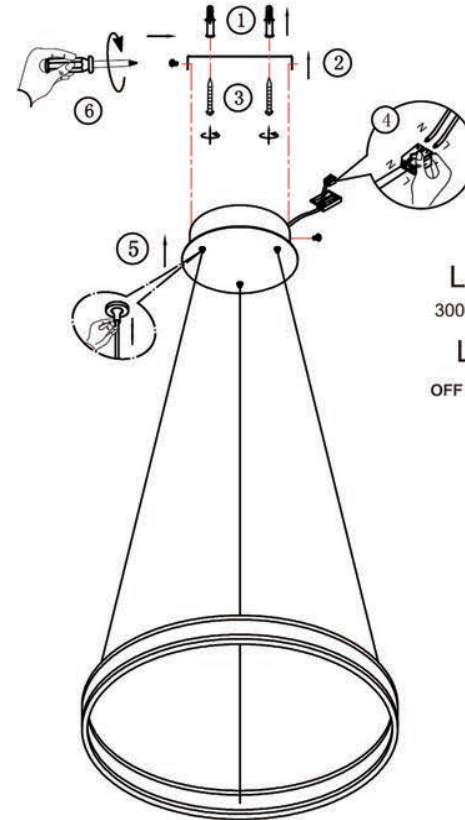

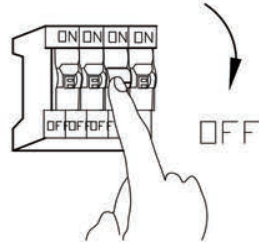

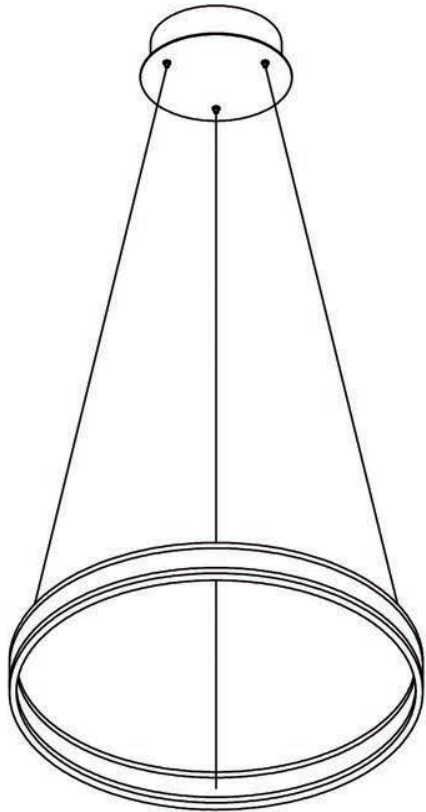

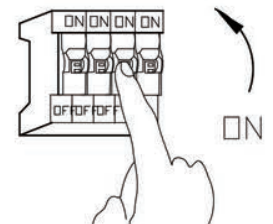



ITEM NO.:BL12501/BL12502



REMARKS: "M1 ,M2"
Hold for 3 seconds to save, then press
the button to change the brightness



2.4G Dimmer Remote Control Instruction

	1		<p>1.Control the main circuit 2.Paring code : Lamp connect electricity with three seconds , hold on the open button 3 times to match the lamp. 3. Clearing code : hold on the o button three time continuously, the lights flash twice.</p>
	2		2.Press this button to turn off the lamp
	3		DIMthe output power is lightened from 20% to 100%
	4		4.Color temperature up, no cycle function
	5		5.Dim the output power from 100% to 20%
	6		Time set 30 minutes, press this key ,the light will flash onece. press any key to turn off the function
	7		7.Night model,output power is lightened 5%. press off button can turn off it .
	8		/
	9		9.Gradual change cool white.100% warm light,50%warm light and 50% white light ,100% white light
	10		10.Gradual change cool whiteChange to warm light ,(warm light),no cycle.
	11		11.Current Brightness,and warm- other -white
	12		/